



---

# User Manual

-Installation

-Operation

---

Omniksol-3k-TL

Omniksol-4k-TL

Omniksol-5k-TL

---

Omnik New Energy Co.,Ltd

---





# CATALOG

- Catalog ..... 3
- 1. Notes on this manual ..... 5
  - 1.1 Scope of Validation ..... 5
  - 1.2 Symbols Used ..... 5
  - 1.3 Target Group ..... 6
- 2. Preparation ..... 7
  - 2.1 Safety Instructions ..... 7
  - 2.2 Explanations of Symbols on Inverter ..... 9
- 3. Product Information ..... 11
  - 3.1 Overview ..... 11
  - 3.2 Major Characteristics ..... 12
  - 3.3 Datasheet ..... 13
- 4. Packing checklist ..... 18
  - 4.1 Assembly parts ..... 18
  - 4.2 Product Appearance ..... 19
  - 4.3 Product Identification ..... 20
  - 4.4 Further Information ..... 20
- 5. Installation ..... 21
  - 5.1 Safety ..... 21
  - 5.2 Mounting Instructions ..... 21
  - 5.3 Safety Clearance ..... 22
  - 5.4 Mounting Procedure ..... 23
  - 5.5 Safety lock ..... 24
- 6. Electrical Connection ..... 26
  - 6.1 Safety ..... 26
  - 6.2 Overview of Connection Area ..... 26
  - 6.3 AC Side Connection ..... 27
  - 6.4 DC Side Connection ..... 29
  - 6.5 Communication and Monitoring Device ..... 34
- 7. Display ..... 35
  - 7.1 LCD Panel ..... 35



7.2	LCD Display.....	36
7.3	Set Language.....	38
7.4	Choosing safety regulation after starting up.....	39
7.5	State Information .....	40
8.	Recycling and Disposal.....	41
9.	Troubleshooting.....	42
10.	Abbreviation .....	43
11.	Contact .....	44

## 1. NOTES ON THIS MANUAL

### 1.1 Scope of Validation

The main purpose of this User's Manual is to provide instructions and detailed procedures for installing, operating, maintaining, and troubleshooting the following two types of Omnik New Energy-Solar Inverters:

- Omniksol-3k-TL
- Omniksol-4k-TL
- Omniksol-5k-TL

Please keep this user manual all time available in case of emergency.

### 1.2 Symbols Used



#### **DANGER**

DANGER indicates a hazardous situation which, if not avoided, will result in death or serious injury.



#### **WARNING**

WARNING indicates a hazardous situation which, if not avoided, can result in death or serious injury or moderate injury.



#### **CAUTION**

CAUTION indicates a hazardous condition which, if not avoided, can result in minor or moderate injury.



#### **NOTICE**

NOTICE indicates a situation that can result in property damage, if not avoided.

### 1.3 Target Group

- Chapter 1, 2, 3, 4, 7, 8, 9, 10 and chapter 11 are intended for anyone who is intended to use Omnik Grid Tie Solar Inverter. Before any further action, the operators must first read all safety regulations and be aware of the potential danger to operate high-voltage devices. Operators must also have a complete understanding of this device's features and functions.



#### WARNING

Do not use this product unless it has been successfully installed by qualified personnel in accordance with the instructions in Chapter 5, "Installation".

- Chapter 5 and chapter 6 are only for qualified personnel who are intended to install or uninstall the Omnik Grid Tie Solar Inverter.



#### NOTICE

Hereby qualified personnel means he/she has the valid license from the local authority in:

- Installing electrical equipment and PV power systems (up to 1000 V).
- Applying all applicable installation codes.
- Analyzing and reducing the hazards involved in performing electrical work.
- Selecting and using Personal Protective Equipment (PPE).

## 2. PREPARATION

### 2.1 Safety Instructions



#### **DANGER**

---

##### **DANGER due to electrical shock and high voltage**

**DO NOT** touch the operating component of the inverter, it might result in burning or death.

**TO** prevent risk of electric shock during installation and maintenance, please make sure that all AC and DC terminals are plugged out.

**DO NOT** stay close to the instruments while there is severe weather conditions including storm, lighting etc.



#### **WARNING**

---

The installation, service, recycling and disposal of the inverters must be performed by qualified personnel only in compliance with national and local standards and regulations. Please contact your dealer to get the information of authorized repair facility for any maintenance or repairmen.

Any unauthorized actions including modification of product functionality of any form will affect the validation of warranty service; Omnik may deny the obligation of warranty service accordingly.



#### **NOTICE**

---

##### **Public utility only**

The PV inverter designed to feed AC power directly into the public utility power grid, do not connect AC output of the device to any private AC equipment.



## CAUTION

---











The PV inverter will become hot during operation; please don't touch the heat sink or peripheral surface during or shortly after operation.

Risk of damage due to improper modifications.

Never modify or manipulate the inverter or other components of the system.



## 2.2 Explanations of Symbols on Inverter

Symbol	Description
	<b>Dangerous electrical voltage</b> This device is directly connected to public grid, thus all work to the inverter shall only be carried out by qualified personnel.
	<b>DANGER to life due to high electrical voltage!</b> There might be residual currents in inverter because of large capacitors. Wait <b>10 MINUTES</b> before you remove the front lid.
	<b>NOTICE, danger!</b> This device directly connected with electricity generators and public grid.
	<b>Danger of hot surface</b> The components inside the inverter will release a log of heat during operation, DO NOT touch aluminum housing during operating.
	<b>An error has occurred</b> Please go to Part 10 "Trouble Shooting" to remedy the error.
	<b>This device SHALL NOT be disposed of in residential waste</b> Please go to Part 9 "Recycling and Disposal" for proper treatments.
	<b>Without Transformer</b> This inverter does not use transformer for the isolation function.
	<b>German mark of conformity</b> The inverter complies with the requirement of the German Grid Regulations.
	<b>Certified Safety</b> The inverter complies with the requirements of the Equipment and Product Safety Act in Europe.
	<b>Standards Association of Australian</b> The inverter complies with the requirement of the AS4777.
	<b>CE Mark</b> Equipment with the CE mark fulfils the basic requirements of the Guideline Governing Low-Voltage and Electromagnetic Compatibility.

**ATTENTION!**   
Any illegal tempering activity  
to electronic or mechanic  
components(perforations,  
modifications, etc ) will affect  
the validation of the factory  
guaranty.

**No unauthorized perforations or modifications**

Any unauthorized perforations or modifications are strictly forbidden, if any defect or damage (device/person) is occurred, Omnik shall not take any responsibility for it.

## 3. PRODUCT INFORMATION

### 3.1 Overview

- Industrial Layout



- Excellent Heat Elimination



- Effective Shield For DC/AC/Communication Connections



### 3.2 Major Characteristics

Omnik inverter has following characteristics which make Omnik inverter “High Efficiency, High Reliability, High Cost Effective Ratio”

- Wide DC input voltage and current range, enables more PV panels connected.
- Wide MPP voltage range ensure high yield under various weather conditions.
- High MPP tracking accuracy, ensure the minimum power loses during converting.
- Complete set of protection methods.

Also, following protection methods are integrated in Omnik inverter:

- Internal overvoltage
- DC insulation monitoring
- Ground fault protection
- Grid monitoring
- Ground fault current monitoring
- DC current monitoring
- Integrated DC switch (Optional)

### 3.3 Datasheet

#### Omniksol-3k-TL

Type		Omniksol-3k-TL
<b>Input (DC)</b>		
Max. PV-generator power	$P_{pv}$ [W]	3400
Max. DC voltage	$V_{max(DC)}$ [V]	590
MPPT DC voltage range	$V_{mppt}$ [V]	120 – 500
Turn off DC Voltage	$V_{min(DC)}$ [V]	120
Max. DC current	$I_{max(DC)}$ [A]	36
Nominal DC current	$I_{N(DC)}$ [A]	28
Number of DC connection		2
DC-connection		MC4
Number of MPP trackers		2
Turn on power	$P_{min(DC)}$ [W]	10
<b>Output (AC)</b>		
Max. AC Power	$P_{max(AC)}$ [W]	3300
Nominal AC power	$P_{N(AC)}$ [W]	3000
Max. AC current	$I_{max(AC)}$ [A]	14.4
Nominal AC current	$I_{N(AC)}$ [A]	13
Power connection		Single phase
Grid voltage range		According to VDE 0126-1-1, RD1663, ENEL2010,C10/11, G83/1 AS4777
Grid frequency range		According to VDE 0126-1-1, RD1663, ENEL2010,C10/11, G83/1, AS4777
Power factor		0.99 (>30% of Full Load)
Harmonic distortion (THD) at nominal output		<2%
AC Connector		Plug-in connector
<b>Power consumption</b>		
Own consumption in operation	$P_{own(AC)}$ [W]	45
Power consumption at night	$P_{nig(AC)}$ [W]	0
Power consumption at standby	$P_{std(AC)}$ [W]	6
<b>Efficiency</b>		
Max. Efficiency (at 360VDC)		97.4%
Euro efficiency (at 360VDC)		96.6%
MPPT efficiency		99.9%
<b>Safety and protection</b>		
Internal overvoltage protection		Yes
DC Insulation monitoring		Yes
Earth fault protection		Yes
Grid monitoring		According to VDE 0126-1-1, RD1663, ENEL2010,C10/11, G83/1, AS4777
Earth fault current monitoring		According to VDE 0126-1-1, RD1663, ENEL2010,C10/11, G83/1, AS4777
DC current monitoring		According to VDE 0126-1-1, RD1663, ENEL2010,C10/11, G83/1, AS4777
Islanding protection		According to VDE 0126-1-1, RD1663, G83/1, AS4777
<b>Normative reference</b>		
CE- compliant according to		EN 62109, EN 61000-6-1, EN 61000-6-3, EN 61000-6-2, EN 61000-6-4 EN61000-3-2, EN61000-3-3, EN61000-3-12, EN61000-3-11

**Dimensions and weight**

Dimensions (WxHxD)	[mm]	367x526x163
Weight	[kg]	20

**Environmental limits**

IP protection type		IP 65 according to IEC 60529
Operating temperature range		-20°C to +60°C
Relative humidity		0% to 98%, no condensation
Maximum altitude (above sea level)	[m]	2000
Noise level	[dBA]	< 40

**General data**

Isolation type		Transformerless
Cooling concept		Convection
Housing		metal housing for inside and outside installation
Mounting information		Wall bracket
LED display		3
LCD display		Backlight, 16 x 2 Character LCD
Data logger		
Data communication interfaces		RS485, Optional (Wi-Fi, GPRS, Ethernet)
Computer Communication		RS232 as Option
Standard warranty		5 years (optional 10 years)

**Omniksol-4k-TL**
**Type** **Omniksol-4k-TL**
**Input (DC)**

Max. PV-generator power	$P_{pv}$ [W]	4500
Max DC voltage	$V_{max(DC)}$ [V]	590
MPPT DC voltage range	$V_{mppt}$ [V]	120 – 500
Turn off DC Voltage	$V_{min(DC)}$ [V]	120
Max. DC current	$I_{max(DC)}$ [A]	36
Nominal DC current	$I_{N(DC)}$ [A]	33
Number of DC connection		2
DC-connection		MC4
Number of MPP trackers		2
Turn on power	$P_{min(DC)}$ [W]	10

**Output (AC)**

Max. AC Power	$P_{max(AC)}$ [W]	4400
Nominal AC power	$P_{N(AC)}$ [W]	4000
Max. AC current	$I_{max(AC)}$ [A]	19.0
Nominal AC current	$I_{N(AC)}$ [A]	17.4
Power connection		Single phase
Grid voltage range		According to VDE 0126-1-1, RD1663, ENEL2010,C10/11 G83/1 AS4777
Grid frequency range		According to VDE 0126-1-1, RD1663, ENEL2010,C10/11, G83/1, AS4777
Power factor		0.99 (>30% of Full Load)
Harmonic distortion (THD) at nominal output		<2%
AC Connector		Plug-in connector

**Power consumption**

Own consumption in operation	$P_{own(AC)}$ [W]	50
------------------------------	-------------------	----

Power consumption at night	$P_{nig(AC)}$ [W]	0
Power consumption at standby	$P_{std(AC)}$ [W]	6
<b>Efficiency</b>		
Max. Efficiency (at 360VDC)		97.6%
Euro efficiency (at 360VDC)		97.0%
MPPT efficiency		99.9%
<b>Safety and protection</b>		
Internal overvoltage protection		Yes
DC Insulation monitoring		Yes
Earth fault protection		Yes
Grid monitoring		According to VDE 0126-1-1, RD1663, ENEL2010,C10/11, G83/1, AS4777
Earth fault current monitoring		According to VDE 0126-1-1, RD1663, ,ENEL2010,C10/11, G83/1, AS4777
DC current monitoring		According to VDE 0126-1-1, RD1663, ENEL2010,C10/11, G83/1, AS4777
Islanding protection		According to VDE 0126-1-1, RD1663, G83/1, AS4777
<b>Normative reference</b>		
CE- compliant according to		EN 62109, EN 61000-6-1, EN 61000-6-3, EN 61000-6-2, EN 61000-6-4 EN61000-3-2, EN61000-3-3, EN61000-3-12, EN61000-3-11
<b>Dimensions and weight</b>		
Dimensions (WxHxD)	[mm]	367x526x163
Weight	[kg]	21
<b>Environmental limits</b>		
IP protection type		IP 65 according to IEC 60529
Operating temperature range		-20°C to +60°C
Relative humidity		0% to 98%, no condensation
Maximum altitude (above sea level)	[m]	2000
Noise level	[dBA]	< 40
<b>General data</b>		
Isolation type		Transformerless
Cooling concept		Convection
Housing		metal housing for inside and outside installation
Mounting information		Wall bracket
LED display		3
LCD display		Backlight, 16 x 2 Character LCD
Data logger		RS485, Optional (Wi-Fi, GPRS, Ethernet)
Data communication interfaces		
Computer Communication		RS232 as Option
Standard warranty		5 years (optional 10 years)

Type		Omniksol-5k-TL
<b>Input (DC)</b>		
Max. PV-generator power	$P_{pv}$ [W]	5000
Max DC voltage	$V_{max(DC)}$ [V]	590
MPPT DC voltage range	$V_{mppt}$ [V]	120 – 500
Turn off DC Voltage	$V_{min(DC)}$ [V]	120
Max. DC current	$I_{max(DC)}$ [A]	36
Nominal DC current	$I_{N(DC)}$ [A]	33
Number of DC connection		2
DC-connection		MC4
Number of MPP trackers		2
Turn on power	$P_{min(DC)}$ [W]	10
<b>Output (AC)</b>		
Max. AC Power	$P_{max(AC)}$ [W]	4800
Nominal AC power	$P_{N(AC)}$ [W]	4600
Max. AC current	$I_{max(AC)}$ [A]	21.0
Nominal AC current	$I_{N(AC)}$ [A]	20
Power connection		Single phase
Grid voltage range		According to VDE 0126-1-1, RD1663, ENEL2010,C10/11, G83/1, AS4777
Grid frequency range		According to VDE 0126-1-1, RD1663, ENEL2010,C10/11, G83/1, AS4777
Power factor		0.99 (>30% of Full Load)
Harmonic distortion (THD) at nominal output		<2%
AC Connector		Plug-in connector
<b>Power consumption</b>		
Own consumption in operation	$P_{own(AC)}$ [W]	50
Power consumption at night	$P_{nig(AC)}$ [W]	0
Power consumption at standby	$P_{std(AC)}$ [W]	6
<b>Efficiency</b>		
Max. Efficiency (at 360VDC)		97.6%
Euro efficiency (at 360VDC)		97.0%
MPPT efficiency		99.9%
<b>Safety and protection</b>		
Internal overvoltage protection		Yes
DC Insulation monitoring		Yes
Earth fault protection		Yes
Grid monitoring		According to VDE 0126-1-1, RD1663, ENEL2010,C10/11, G83/1, AS4777
Earth fault current monitoring		According to VDE 0126-1-1, RD1663, ENEL2010,C10/11, G83/1, AS4777
DC current monitoring		According to VDE 0126-1-1, RD1663, ENEL2010,C10/11, G83/1, AS4777
Islanding protection		According to VDE 0126-1-1, RD1663, G83/1, AS4777
<b>Normative reference</b>		
CE- compliant according to		EN 62109, EN 61000-6-1, EN 61000-6-3, EN 61000-6-2, EN 61000-6-4 EN61000-3-2, EN61000-3-3, EN61000-3-12, EN61000-3-11
<b>Dimensions and weight</b>		
Dimensions (WxHxD)	[mm]	367x526x163



Weight	[kg]	21
<b>Environmental limits</b>		
IP protection type		IP 65 according to IEC 60529
Operating temperature range		-20°C to +60°C
Relative humidity		0% to 98%, no condensation
Maximum altitude (above sea level)	[m]	2000
Noise level	[dBA]	< 40
<b>General data</b>		
Isolation type		Transformerless
Cooling concept		Convection
Housing		metal housing for inside and outside installation
Mounting information		Wall bracket
LED display		3
LCD display		Backlight, 16 x 2 Character LCD
Data logger		RS485, Optional (Wi-Fi, GPRS, Ethernet)
Data communication interfaces		
Computer Communication		RS232 as Option
Standard warranty		5 years (optional 10 years)

## 4. PACKING CHECKLIST

### 4.1 Assembly parts

After you receive the Omnik inverter, please check if there is any damage on the carton, and then check the inside completeness for any visible external damage on the inverter or any accessories. Contact your dealer if anything is damaged or missing.



A



B



C



D

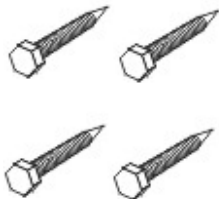

E

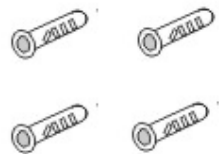

F



G

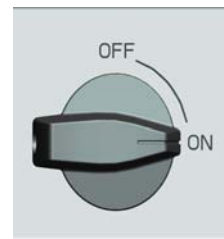

H

Object	Quantity	Description
A	1	Omnik inverter
B	2 pairs	DC connector
C	1	AC connector
D	1	Ring tool to disconnect DC connector
E	4	Screw (ST6×50)
F	4	Expansion tube
G	1	Installation and operating instructions
H	1	DC Switch ( <b>Optional</b> )

## 4.2 Product Appearance

- Front

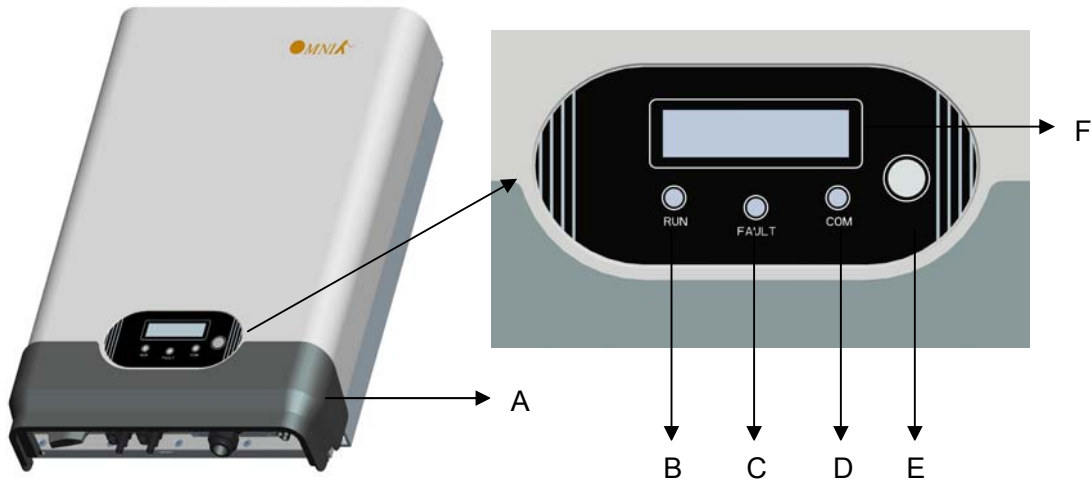

Object	Description
A	Removable front shield
B	LED light(Green) – RUN
C	LED light(Red) – FAULT
D	LED light(Yellow) – COM
E	Function key for displays and choice of language
F	Monitoring LCD with backlighting

- Bottom

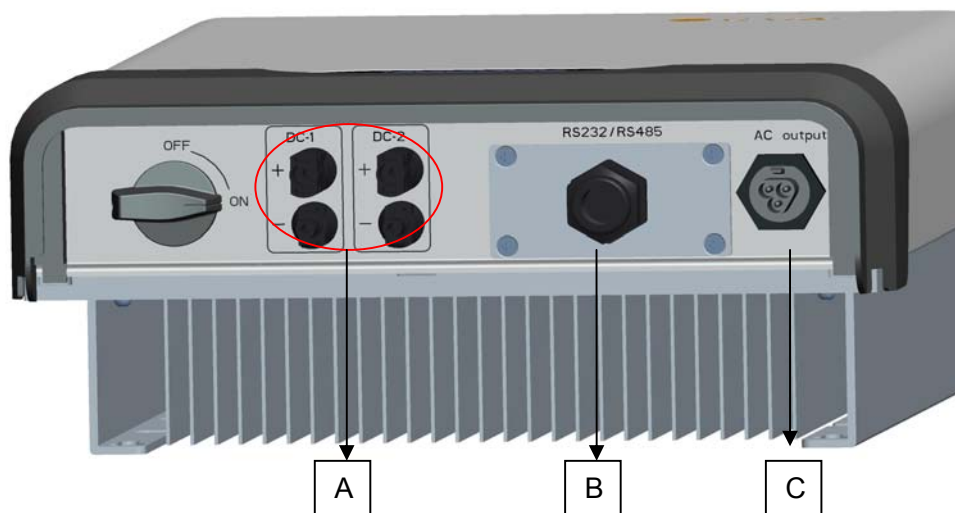

Object	Description
A	Plug connectors for DC input.
B	RS232/RS485 interface
C	Terminal for grid connection (AC output)

### 4.3 Product Identification

You can identify the inverter by the side name plate. Information such as serial number (SN.), type of the inverter, as well as inverter specifications are specified on the side name plate. The name plate is on the middle part of the right side of the inverter housing. And the following figure is the side name plate example as on Omniksol-3k-TL.

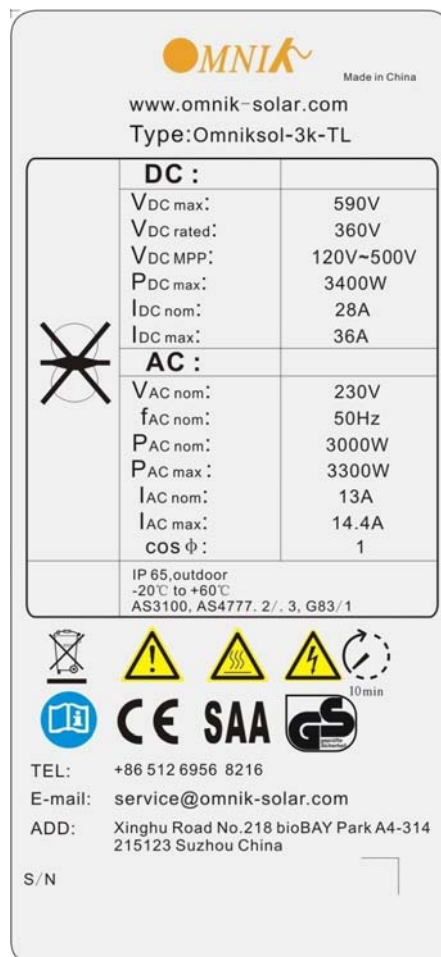

### 4.4 Further Information

If you have any further questions concerning the type of accessories or installation, please check our website [www.omnik-solar.com](http://www.omnik-solar.com) or contact our service hotline.

## 5. INSTALLATION

### 5.1 Safety



#### DANGER

**DANGER to life due to potential fire or electricity shock.**

DO NOT install the inverter near any inflammable or explosive items.

This inverter will be directly connected with HIGH VOLTAGE power generation device, the installation must be performed by qualified personnel only in compliance with national and local standards and regulations.



#### NOTICE

**NOTICE** due to the inappropriate or the harmonized installation environment may jeopardize the life span of the inverter.

Installation directly expose under intensive sunshine is not recommended.

The installation site **MUST** have good ventilation condition.

### 5.2 Mounting Instructions

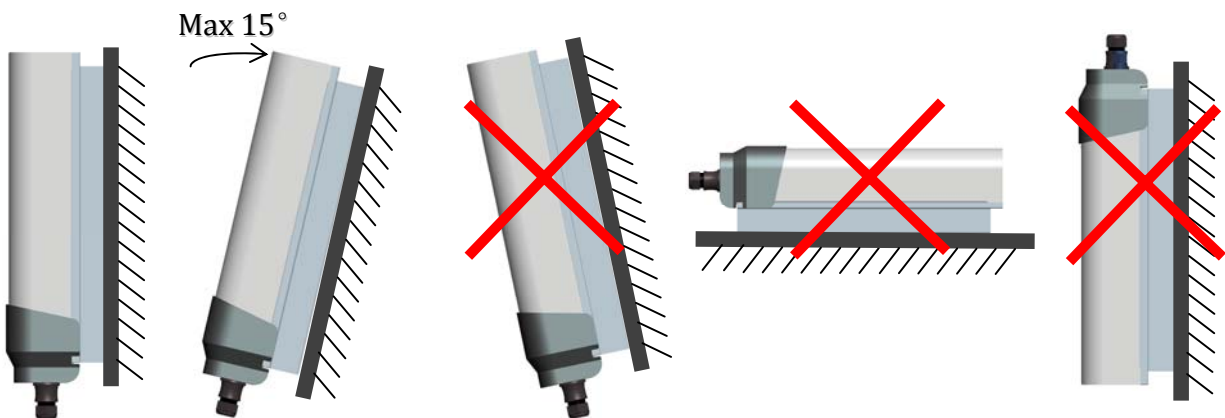

- Omnik inverter is designed for indoors and outdoors installation
- Please mount the inverter in the direction as illustrated above
- Install the inverter in the vertical direction is recommended, with a max.15 degrees backwards.
- For the convenience of checking the LCD display and possible maintenance activities, please install the inverter at eye level.
- Make sure the wall you selected is strong enough to handle the screws and bear the weight of the inverter
- Ensure the device is properly fixed to the wall
- It is not recommended that the inverter is exposed to the strong sunshine, because the excess heating might lead to power reduction
- The ambient temperature of installation site should be between -20 °C and +60 °C ( between -4 °F and 140 °F )
- Make sure the ventilation of the installation spot, not sufficient ventilation may reduce the performance of the electronic components inside the inverter and shorten the life of the inverter

### 5.3 Safety Clearance

Observe the following minimum clearances to walls, other devices or objects to guarantee sufficient heat dissipation and enough space for pulling the electronic solar switch handle.



Direction	Minimum clearance
Above	30 cm
Below	30 cm
Sides	10 cm

### 5.4 Mounting Procedure

1. Mark 4 positions of the drill holes on the wall according to the paper installation position scale packed in the carton box.

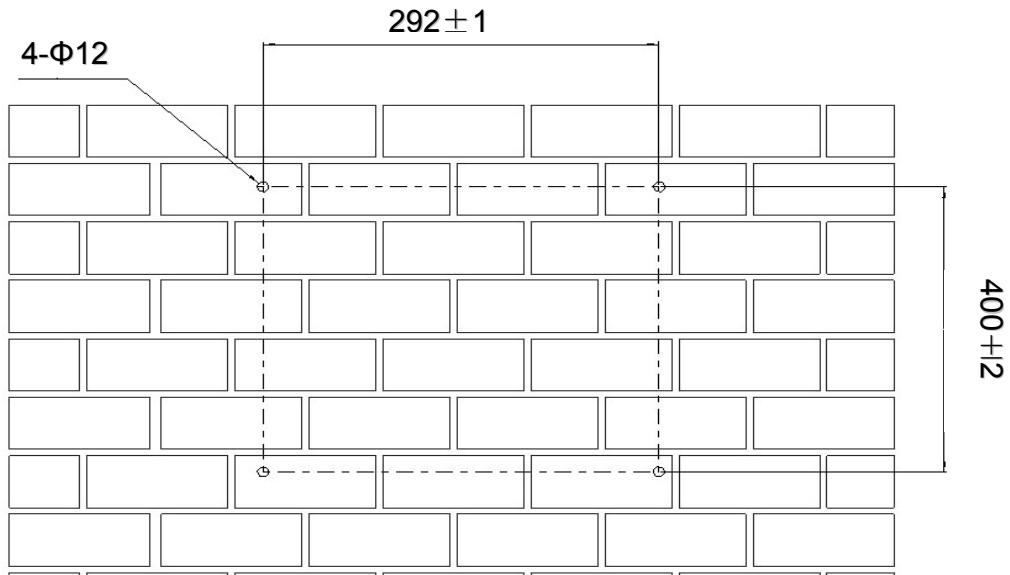

2. First, according to the marks, drill 4 holes in the wall. Then, place four expansion tubes in the holes using a rubber hammer. Next, wring 4 screws into the expansion tubes.

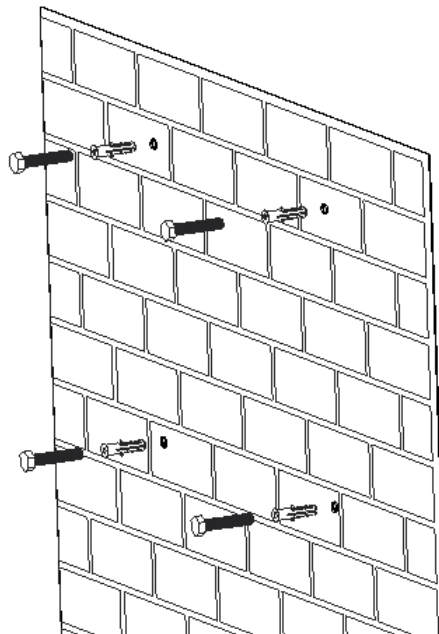

3. First check the 4 holes in the backside of the inverter. Then, lift the inverter carefully, align the 4 holes in the inverter and the 4 screws in the wall, and finally attach the inverter to the screws slightly.

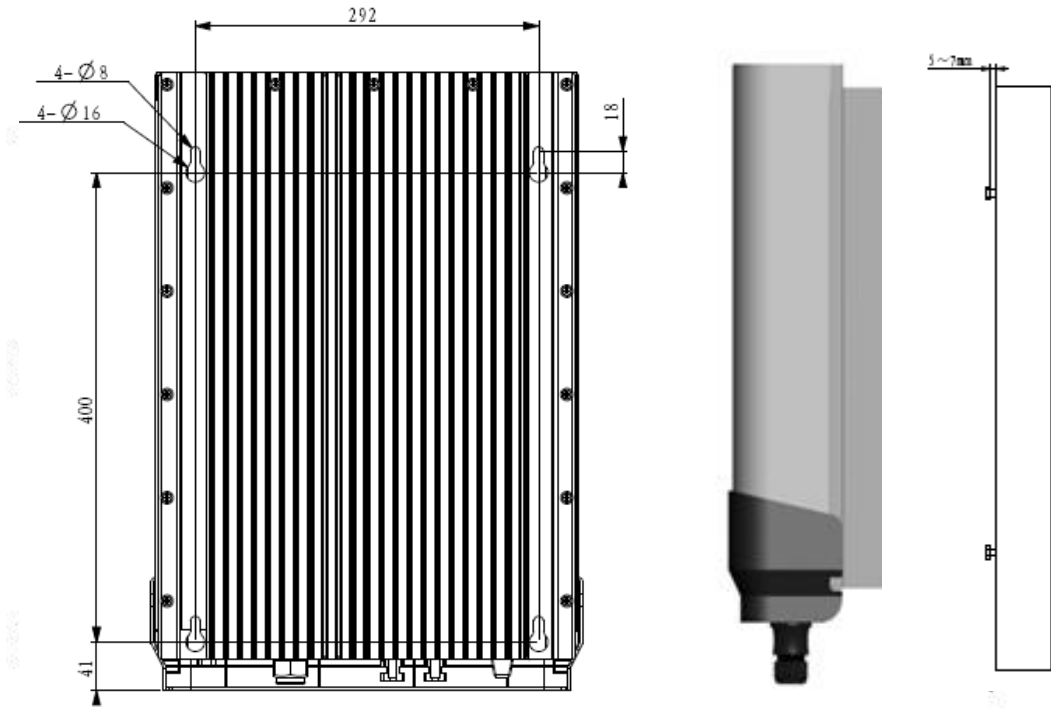

4. Please carefully check the accessories and original carton to make sure every necessary part is used and nothing is missing during installation.

## 5.5 Safety lock

To prevent possible theft activity, Omnik gives you an extra guard for your property. It is possible to lock the inverter to the rear panel with a padlock.





Recommended padlock dimension:

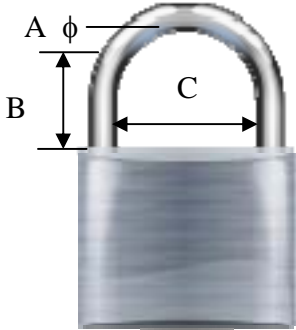

A. Shackle Diameter	5~7 mm
B. Vertical Clearance	8~15 mm
C. Horizontal Clearance	12~20 mm
Stainless, solid hanger and secured lock cylinder	



**NOTICE**

For further maintenance and possible repair, please keep the key of the padlock in a safe place.

After the inverter is hang up on the wall, install the lock bracket on the aluminium radiator at the Lower Right Corner of the inverter (as the picture showed below),make sure the round hole of the lock bracket aim at the hole of the inverter, after that lock up the device.

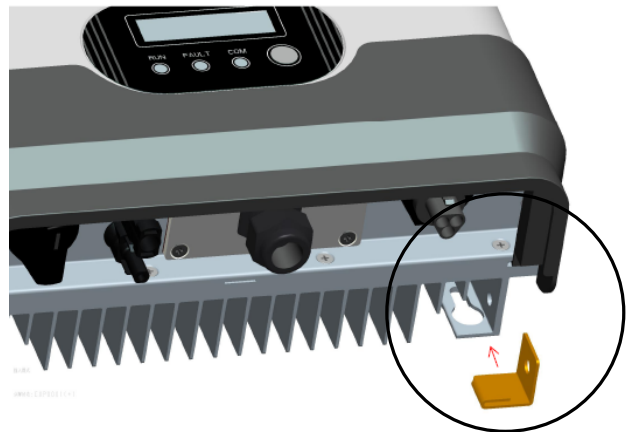
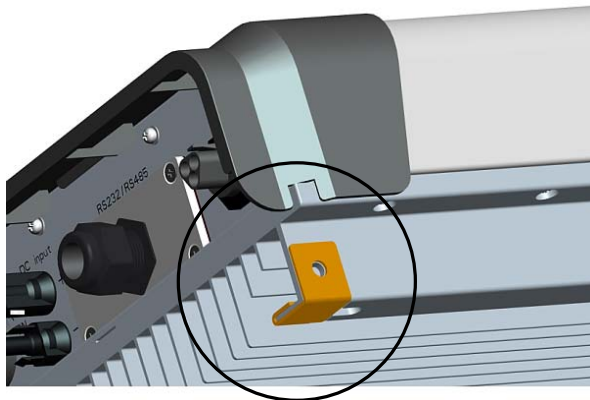

The lock bracket

## 6. ELECTRICAL CONNECTION

### 6.1 Safety



#### DANGER

**DANGER to life due to potential fire or electricity shock.** With the inverter powered, comply with all prevailing national regulations on accidents prevention.

This inverter will be directly connected with HIGH VOLTAGE power generation device, the installation must be performed by qualified personnel only in compliance with national and local standards and regulations.



#### NOTICE

Electrical connections shall be carried out in accordance with the applicable regulations, such as conductor sections, fuses, PE connection.

### 6.2 Overview of Connection Area

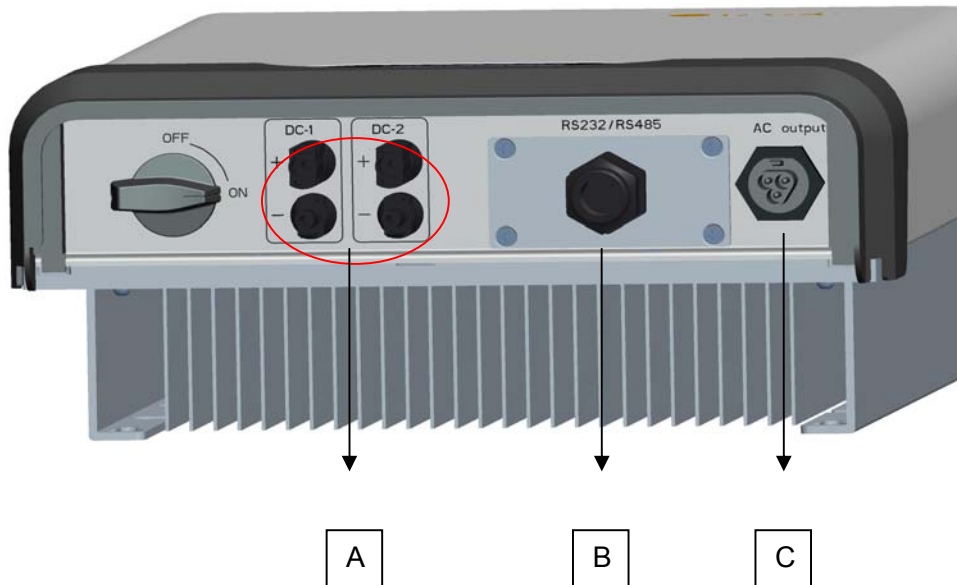

Object	Description
A	Plug connectors for DC input.
B	RS232/RS485 interface
C	Terminal for grid connection (AC output)

### 6.3 AC Side Connection



## DANGER

**DANGER to life due to potential fire or electricity shock.**

**NEVER** connect or disconnect the connectors under load.

#### 1. Integrated RCD and RCM

The Omniksol inverter is equipped with integrated RCD (Residual Current Protective Device) and RCM (Residual Current Operated Monitor). The current sensor will detect the volume of the leakage current and compare it with the pre-set value, if the leakage current exceeds the permitted range, the RCD will disconnect the inverter from the AC load.

#### 2. Assembly Instructions

- 1) Strip the cable with the length 0.276 inches (9/32") - (7mm) and please be careful NOT to nick conductors.

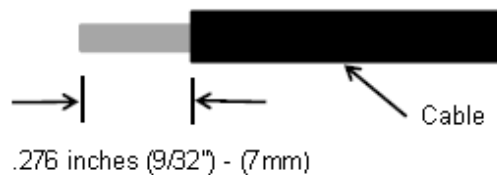

- 2) Screw off and separate each component of AC connector as follows.

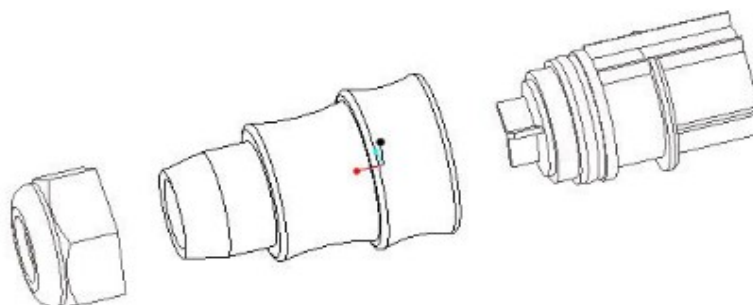

- 3) Pass the cable through each component from left to the right as follows.

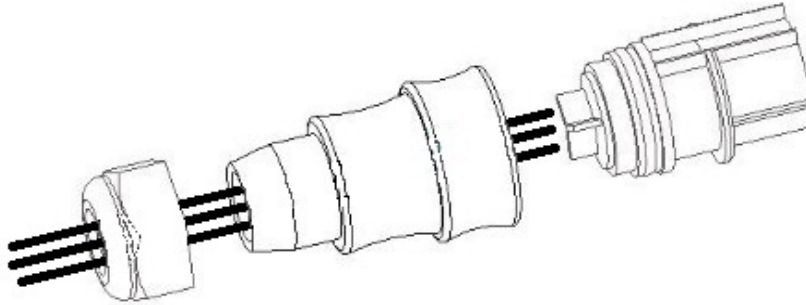

- 4) Use a screw driver and loose the three screws at the side of the straight plug. Then insert the **stripped N, L and PE cable** accordingly to the corresponding position and fully tighten the screws.

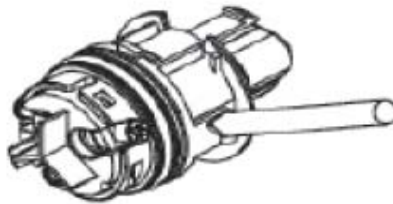

- 5) Aim the terminals on the straight plug to the holes of the grommet, and then compress them together.

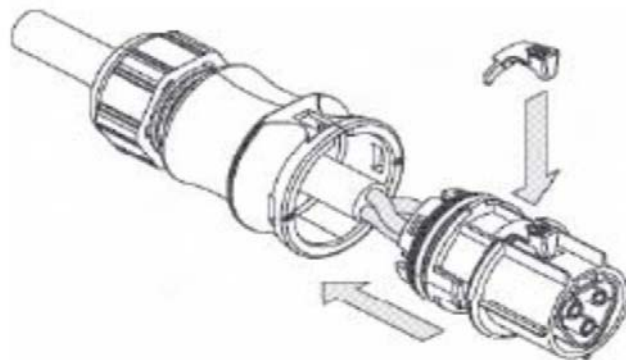

- 6) Finally connect the straight plug to the AC terminal on inverter. **Pay attention to the polarity of the terminals to avoid wrong connecting.**

## 6.4 DC Side Connection



### DANGER

**DANGER to life due to potential fire or electricity shock.**

**NEVER** connect or disconnect the connectors under load.



### NOTICE

DC Switch(**Optional**) may be integrated or external to Inverter, and it can be used to connect or disconnect the DC source from Inverter.

For Omniksol-3k-TL, Omniksol-4k-TL and Omniksol-5k-TL, there are two MPP Trackers, and the DC characteristics of them are illustrated as the following table.

Inverter Type	MPP Tracker	Max. DC Power	Max. DC Voltage	Max. DC Current
Omniksol-3k-TL	2	3400W	590V	36A
Omniksol-4k-TL		4500W		36A
Omniksol-5k-TL		5000W		36A

### MC4 Assembly instructions

 If, during self assembly, parts and tools other than those stated by MC are used or if the preparation and assembly instructions described here are disregarded then neither safety nor compliance with the technical data can be guaranteed.

 For protection against electric shock, PV-connectors must be isolated from the power supply while being assembled or disassembled.

 The end product must provide protection from electric shock.

 The use of PVC cables is not recommended.

 Unplugging under load: PV plug connections must not be unplugged while under load. They can be placed in a no load state by switching off the DC/AC converter or breaking the DC circuit interrupter. Plugging and unplugging while under voltage is permitted.

 It is inadvisable to use non-tinned cables of type H07RN-F, since with oxidised copper wires the contact resistances of the crimp connection may exceed the permitted limits.

 Disconnected connectors should be protected from dirt and water with sealing caps.

 Plugged parts are watertight IP67. They can not be used permanently under water. Do not lay the MC-PV connectors on the roof surface.

 See the MC catalogue 2 Solar line for technical data and assembled parts.

**PV-Female cable coupler**

**PV-Male cable coupler**

**Optional**



PV-KBT4/...



PV-KST4/...



PV-SSH4

Touch protection, mated/unmated	IP67/IP2X	Rated current	17A(1,5mm2/14AWG) 22A(2,5mm2/ 12AWG) 30A(4mm2,6mm2/ 10AWG)
Ambient temperature range	-40° ...90°C (IEC/CEI) - 40° ...75°C(UL) - 40° ...70°C (UL/AWG14)	Rated voltage	1000V (IEC/CEI) 600V (UL)
Upper limiting temperature	105°C (IEC/CEI)	Safety class	II

**Tools required**



ill.1

(ill.1) Crimping tool incl. locator and built-in crimping insert.

Type: PV-ES-CZM-18100

PV-ES-CZM-19100

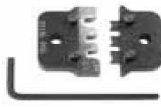

ill.2

(ill.2) Interchangeable crimping

inserts incl. hexagonal screwdriver A/F 2,5.

Type: PV-ES-CZM-18100

PV-ES-CZM-19100



ill.3

(ill.3) Open-end spanner PV-MS 1 set = 2 pieces Order No. 32.6024



ill.4

(ill.4) PV-WZ-AD/GWD socket wrench insert to tighten, Order No. 32.6006



ill.5

(ill.5) PV-SSE-AD4 socket wrench insert to secure PV-SSE-AD4, Order No. 32.6026

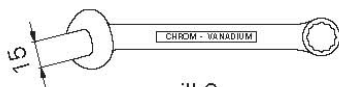

ill.6

(ill.6) Open-end spanner A/F 15 mm



ill.7

(ill.7) Torque screwdriver A/F 12 mm



ill.8

(ill.8) Test plug PV-PST

Order No.: 32.6028



iii.9

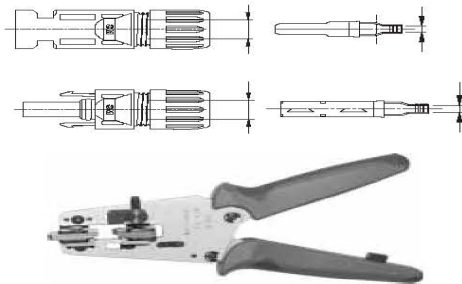

iii.10

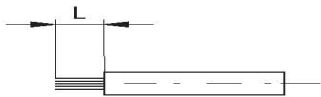

### Cable preparation

(iii.9) Important: Cables with class 2, 5 or 6 construction can be connected. It is advantageous to use tinned conductors. It is unadvisable to use non-tinned cables of type H07RN-F, since with oxidised copper wires the contact resistances of the crimp connection may exceed the permitted limits.

Check dimension b according to the following table:

Type	A = $\varnothing$ -range of cable	b control dimension	Conductor cross section	
	mm	mm	mm <sup>2</sup>	AWG
PV-K...T4/...2,5I	3 - 6	3	1,5 - 2,5	14
PV-K...T4/...2,5II	5,5 - 9	3	1,5 - 2,5	14
PV-K...T4/...6I	3 - 6	5	4 - 6	12/10
PV-K...T4/...6II	5,5 - 9	5	4 - 6	12/10

(iii.10) Strip cable insulation. L = 6-7, 5 mm. Take care not to cut individual strands.

Recommended tool:

Stripping pliers PV-AZM, Order No.32.6027

### Crimping

(iii.11) Notes to the operation of the crimping pliers, see MA251-def ([www.multicontact.com](http://www.multicontact.com))



iii.11



iii.12

(iii.12) Push the crimped contact into the socket resp. plug insulator until it engages. Pull lightly on the lead to check that the metal part has engaged.



Assembly control



ill. 13

(ill.13) Insert the test pin with the corresponding side into the socket or plug to the end position. If the contact is correctly assembled, the white marking on the test pin

must be still visible.

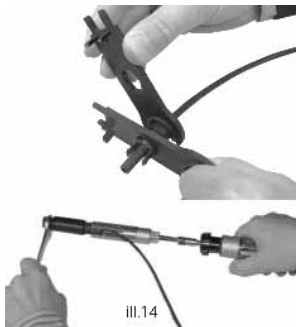

ill.14

(ill.14) Screw on the cable gland, hand-tight, with the tools PV-MS. Or

Screw on the cable gland, with the tools PV-WZ-AD/GWD and PV-SSE-AD4

In any case:

The tightening torque must be adapted to the solar cables used in each specific case. Typical values lie in a range between 2,5 Nm to 3 Nm.

Plugging and unplugging the cable coupler without safety lock clip PV-SSH4

Plugging

(ill.15)

Plug the coupling together until they engage. Check correct engagement by pulling on the coupling.



Unplugging

(ill.16)

Compress the two snap-in springs (X) by hand or with the PV-MS tool and separate the coupling.

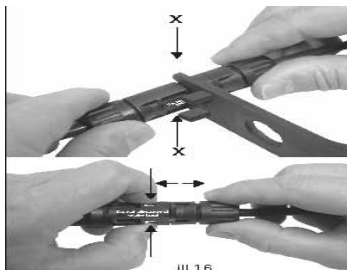

ill.16

Plugging and unplugging the cable coupler without safety lock clip PV-SSH4

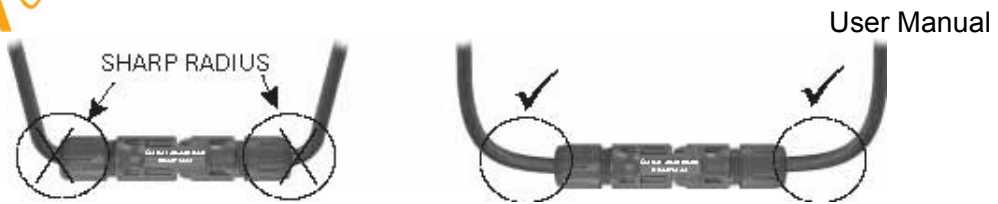

Refer to cable manufactures specification for minimum bending radius.

## 6.5 Communication and Monitoring Device

There are 2 plugs in the bottom side of the Omnik inverter as the following figure:

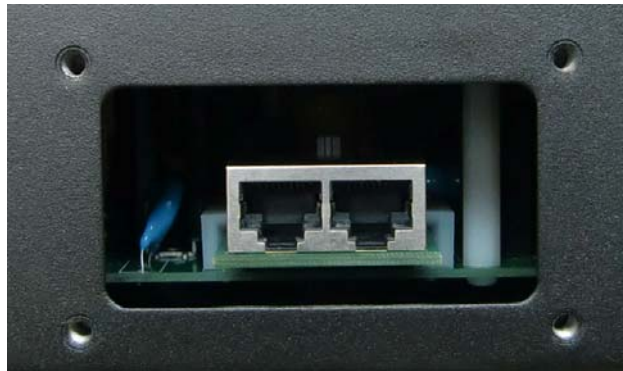

These 2 plugs are used for multipoint communications, that is, up to 50 Omnik inverters can be connected one by one through these 2 plugs and the cables, the upper computer can communicate with these inverters via a single signal cable at the same time, and maximum length of the cable is 1000m. Through these plugs, the user can get the data from these inverters, and can also configure parameters of them.

## 7. DISPLAY

### 7.1 LCD Panel

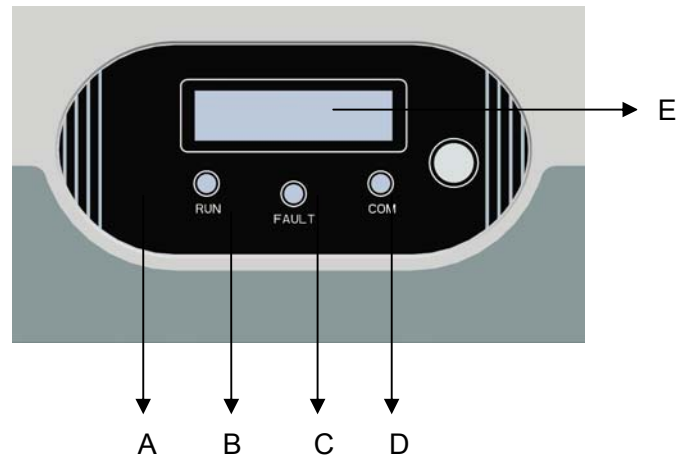

Object	Description
A	LED light(Green) – RUN
B	LED light(Red) – FAULT
C	LED light(Yellow) – COM
D	Function key for displays and choice of language
E	Monitoring LCD with backlighting

The LCD panel is integrated in the front lid of the inverter, so it is easy for user to check and set the data. In addition, the user can press the function key to illuminate the LCD screen.



### NOTICE

Omnik inverter is not an aligned measuring instrument for current, voltage or power consumption. A slight deviation of a few percent points is intrinsic to the system, the results from the inverter cannot be used for grid balance calculations. An aligned meter will be required to make calculations for the utility company.

## 7.2 LCD Display



### NOTICE

Make sure the DC switch(**Optional**) is switched to “On” position, otherwise the inverter cannot work due to power shortage.

The display content consists of 2 lines. The bottom line (Line 2) always displays the output power ( $P_{ac} = \text{xxxx W}$ ). The top line (Line 1) shows current state information by default, and by pressing function key it will display different operating information as the following flow chart and table.

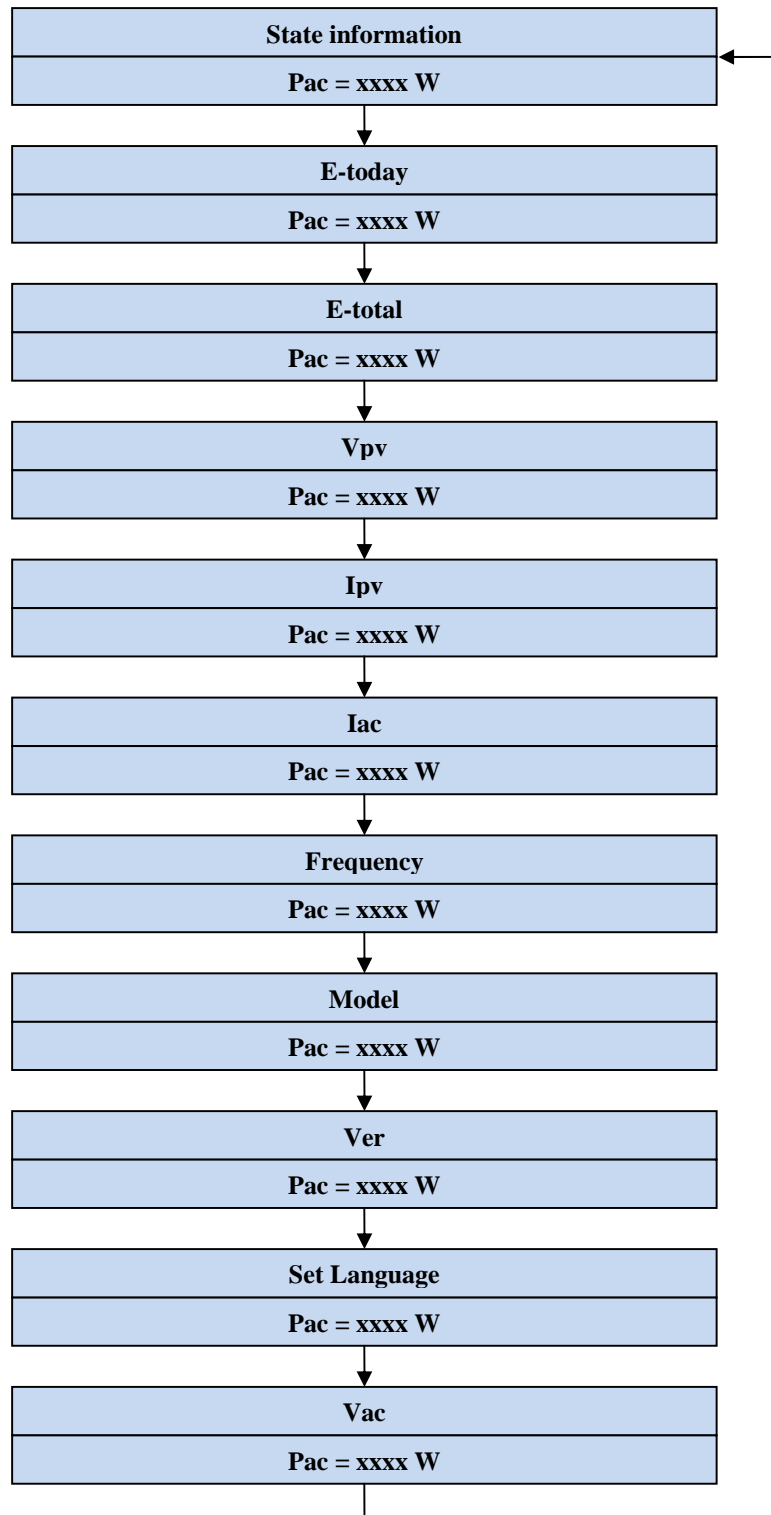

Line 1	Description
State information	Current state information: all possible content shows in the following table, reference to 7.4 for further information
E-today	The energy generated today in kilo watt hours (kWh)
E-total	The energy generated since starting up the inverter (kWh)
Vpv	The present voltage of the solar generator
Ipv	The present current of the solar generator
Iac	The present grid current
Frequency	The grid frequency
Model	The type of the inverter
Ver	The Firmware version
Set Language	Several languages are provided for users, reference to 7.3 for further information
Vac	The grid voltage

### 7.3 Set Language

The Omnik inverter provides several languages for users to use. At the entry of “Set Language”, press the key for approx. 5 seconds, you can enter the language selection menu. Choose the language which you need with the function key, and keep this state without any operation. When it returns to the main menu automatically, the setting has been saved.

## 7.4 Choosing safety regulation after starting up

### 1. Attentions before the operation:

Only perform this operation when the voltage value displayed on Omnik inverter's LCD falls between 150V and 450V for 1.5kW/2.0kW inverters or between 150V and 550V for 3.0kW/4.0kW/5.0kW inverters.

Only perform this operation when the accumulative generated electricity is less than 1KWh.

### 2. Operation steps are as following:

2.1 Power on the inverter with only DC side connected, while disconnecting cables of AC side.



2.2 Press the Function button until the LCD displays inverter's model and hold the button for 5 seconds or more when the LCD displays the current Safety Standard. Change the standard by pressing the Function button one at a time.

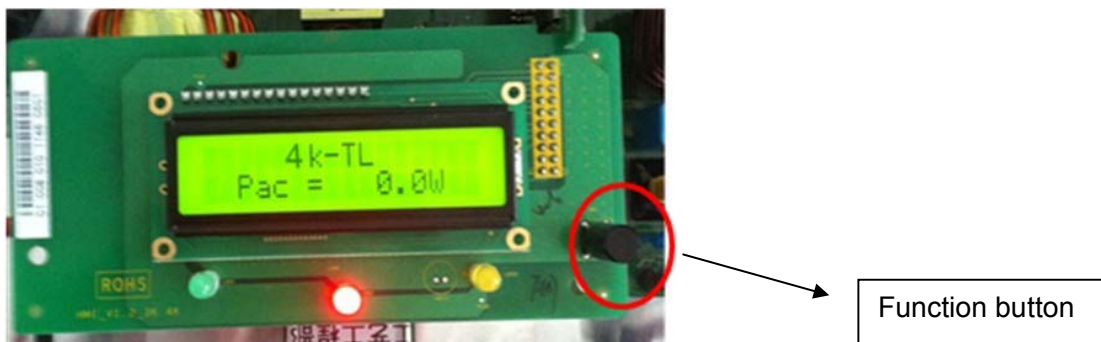

2.3 When the LCD displays your desired Safety Standard, hold the Function button for 5 seconds or more until it shows "Safety Standard OK".



2.4 The Safety Standard setup is now completed.

## 7.5 State Information

State	Display	State information
Wait	Waiting	Initialization & waiting
	Reconnect s	Reconnect
	Checking s	Checking
Normal	Normal	Normal state
Fault	Ground I Fault	GFCI failure oversized leakage current
	Fac Failure	Grid frequency failure
	Vac Failure	Grid voltage failure
	Utility Loss	No Utility&Island
	PV Over Voltage	Input voltage too high
	Over Temperature	Temperature abnormal
	Isolation Fault	Isolation failure
	Relay-Check Fail	Output relay failure
	DC INJ High	Output DC injection too high
EEPROM R/W Fail	EEPROM problem	



	SCI Failure	Serial communication interface failure
	AC HCT Failure	Output AC sensor abnormal
	GFCI Failure	GFCI testing device abnormal
Flash	F/W Updating	Update

About the further information for each fault, please reference to chapter “9.TROUBLESHOOTING”.

## 8. RECYCLING AND DISPOSAL

To comply with European Directive 2002/96/EC on waste Electrical and Electronic Equipment and its implementation as national law, electrical equipment that has reached the end of its life must be collected separately and returned to an approved recycling facility. Any device that you no longer required must be returned to your dealer or you must find an approved collection and recycling facility in your area.

Ignoring this EU Directive may have severe affects on the environment and your health.



**WARNING**

---



**This device SHALL NOT be disposed of in residential waste.**

## 9. TROUBLESHOOTING

	LCD display	Possible actions
<b>Resumable Fault</b>	Isolation Fault	<ol style="list-style-type: none"> <li>1. Check the impedance between PV (+) &amp; PV (-) and the inverter is earthed. The impedance must be greater than 2MΩ.</li> <li>2. Check whether the AC-side has contacts with earth.</li> </ol>
	Ground I Fault	<ol style="list-style-type: none"> <li>1. The ground current is too high.</li> <li>2. After cut off the AC side connection, unplug the inputs from the PV generator and check the peripheral AC system.</li> <li>3. After the cause is cleared, re-plug the PV panel and AC connection, and check PV-Inverter status.</li> </ol>
	Grid Fault Fac Over Range Vac Over Range	<ol style="list-style-type: none"> <li>1. Wait for a moment, if the grid returns to normal, PV-Inverter automatically restarts.</li> <li>2. Make sure grid voltage and frequency meet the specifications.</li> </ol>
	Utility Loss	<ol style="list-style-type: none"> <li>1. Grid is not connected.</li> <li>2. Check grid connection cables.</li> <li>3. Check grid usability.</li> <li>4. If grid is ok, and the problem persists, maybe the fuse in the inverter is open, please call service.</li> </ol>
	Over Temperature	<ol style="list-style-type: none"> <li>1. The internal temperature is higher than specified normal value.</li> <li>2. Find a way to reduce the ambient temperature.</li> <li>3. Or move the inverter to a cooler environment.</li> </ol>
	PV over Voltage	<ol style="list-style-type: none"> <li>1. Check the open PV voltage, see if it is greater than or too close to 590VDC (for Omniksol-3k-TL or Omniksol-4k-TL or Omniksol-5k-TL).</li> <li>2. If PV voltage is less than 590VDC, and the problem still occurs, please call local service.</li> </ol>
	<b>Permanent Fault</b>	Consistent Fault
Relay-Check Fail		<ol style="list-style-type: none"> <li>1. Disconnect ALL PV (+) or PV (-).</li> <li>2. Wait for a few seconds.</li> <li>3. After the LCD switches off, reconnect and check again.</li> <li>4. If the problems remain please call local service.</li> </ol>
DC INJ High		
EEPROM R/W Fail		
SCI Failure		
AC HCT Fault		
GFCI Failure		

## 10. ABBREVIATION

LCD	Liquid Crystal Display
LED	Light Emitting Diode
MPPT	Maximum Power Point Tracking
PV	Photovoltaic
Vdc	Voltage at the DC side
Vac	Voltage at the AC side
Vmpp	Voltage at the Maximum Power Point
Impp	Amperage at Maximum Power Point
AC	Alternating Current ( Form of electricity supplied by Utility Company )
DC	Direct Current ( Form of electricity generated by PV modules )
VDE 0126-1-1	German standards for establishing suitability for Grid Connection of the Inverter.
DC Switch	Switch in the DC Circuit. Disconnects DC source from Inverter. May be integrated or external to Inverter.



## 11. CONTACT

### **Suzhou Headquarter**

Xinghu Road No.218 bioBAY Park C2-101 215123 Suzhou China

Tel: +86 512 6295 6676

Fax: +86 512 6295 6682

Email: [info@omnik-solar.com](mailto:info@omnik-solar.com)

[www.omnik-solar.com](http://www.omnik-solar.com)

### **Omnik German Service Center**

An der Pikardie 6

01277 Dresden

Deutschland

Tel: +49 (0)351 30986031

Fax: +49 (0)351 30930022

Email: [service-de@omnik-solar.com](mailto:service-de@omnik-solar.com)

### **Service line**

Tel: +86 512 6295 6676

Fax: +86 512 6295 6682

Email: [service@omnik-solar.com](mailto:service@omnik-solar.com)